

OUEV Floorplans

Venues

[Examination Schools](#)

[Sheldonian Theatre](#)

[St Luke's Chapel](#)

[Osler House](#)

Please note all distances are shown in metres.

⊗ This symbol represents a 13 amp twin socket. These are located throughout our venue spaces and shown on the floorplans.

Examination Schools Floorplans

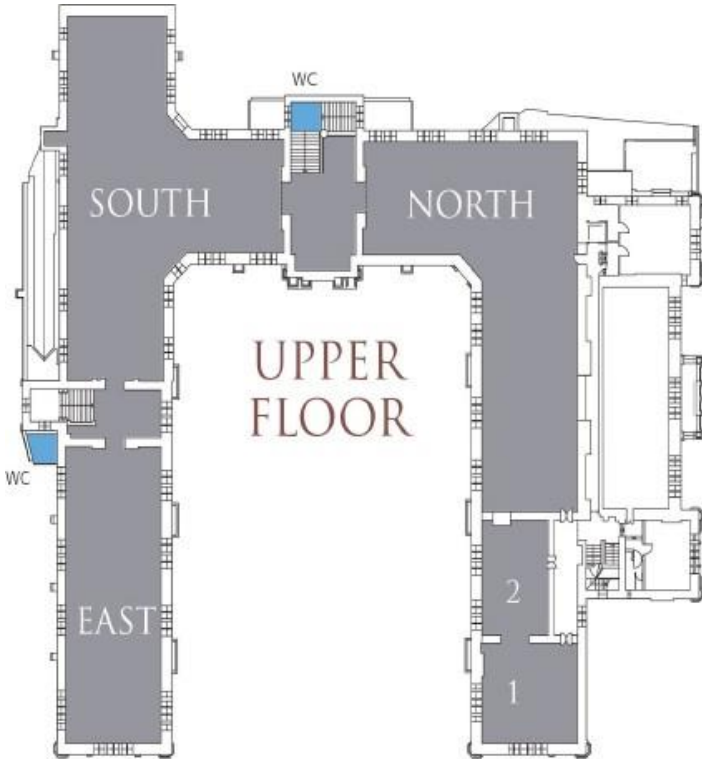

Examination Schools Floorplans

Room 1 and Room 2

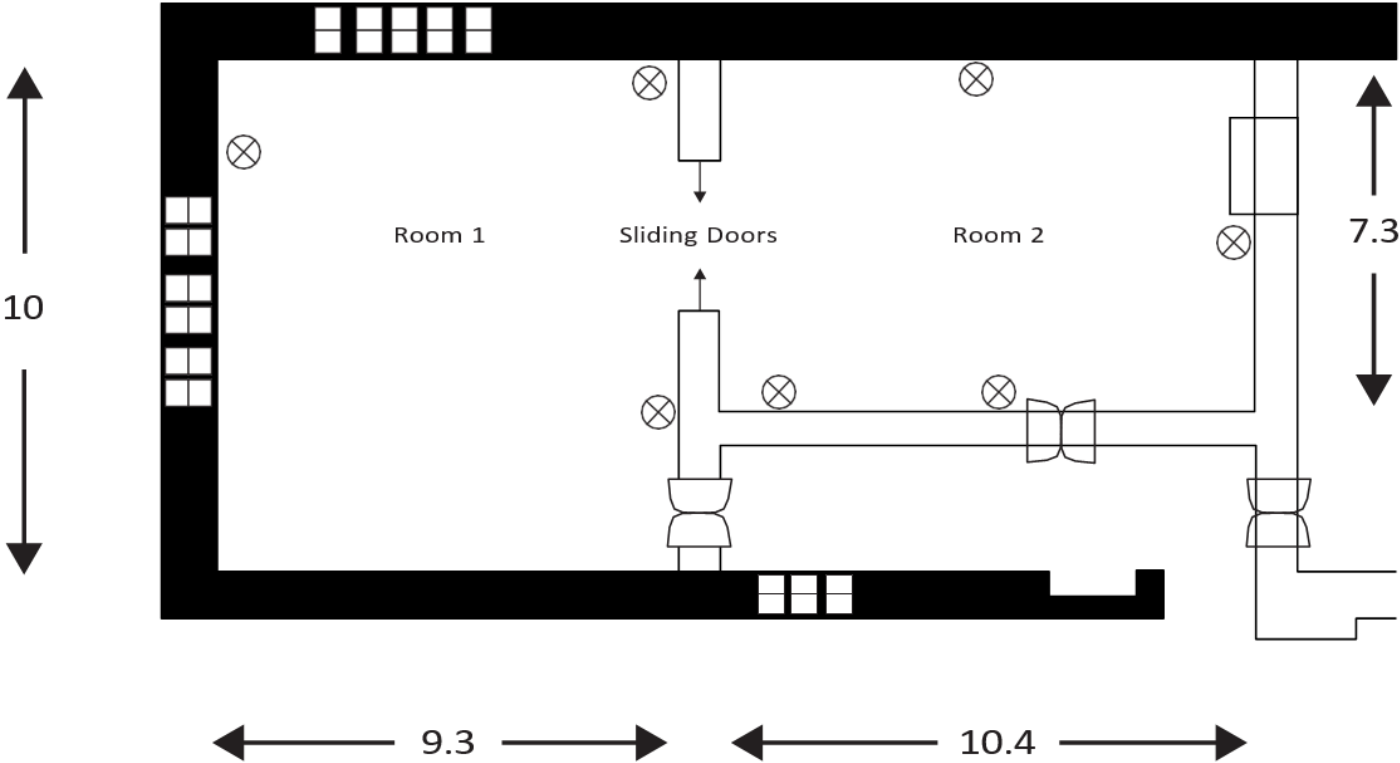

Examination Schools Floorplans
Room 5A

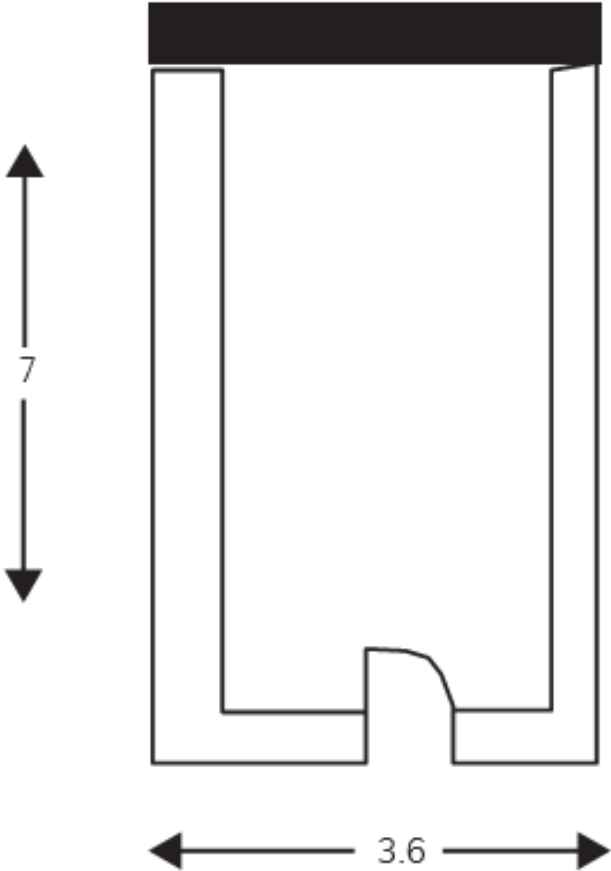

Examination Schools Floorplans
Room 6

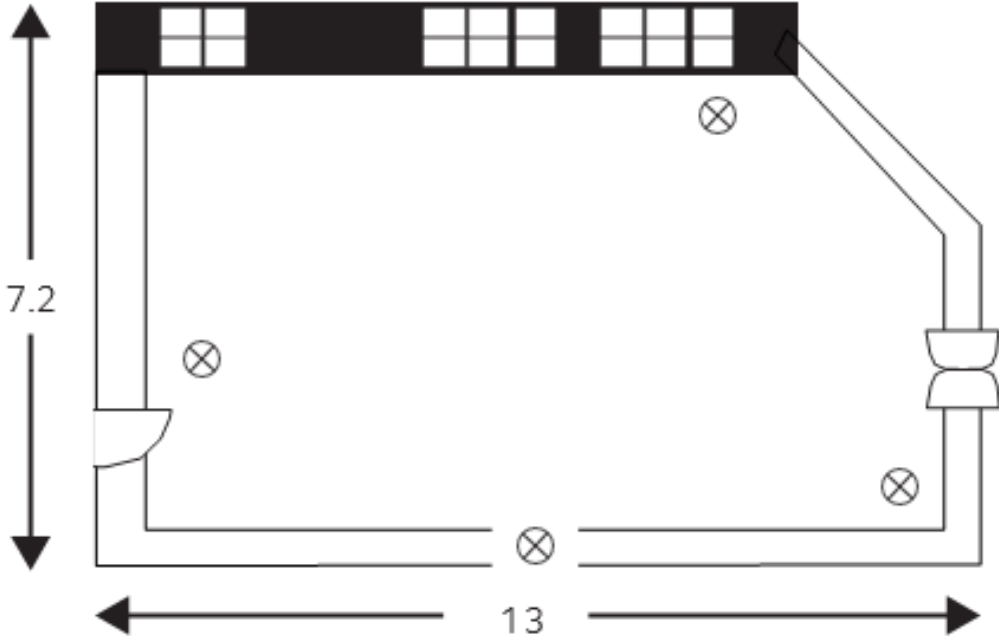

Examination Schools Floorplans
Room 7

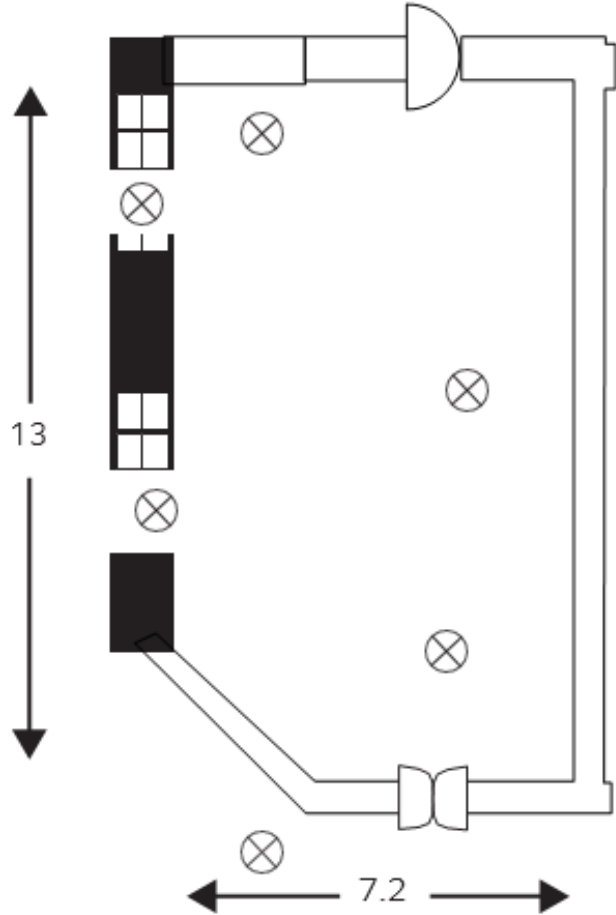

Examination Schools Floorplans
Room 8

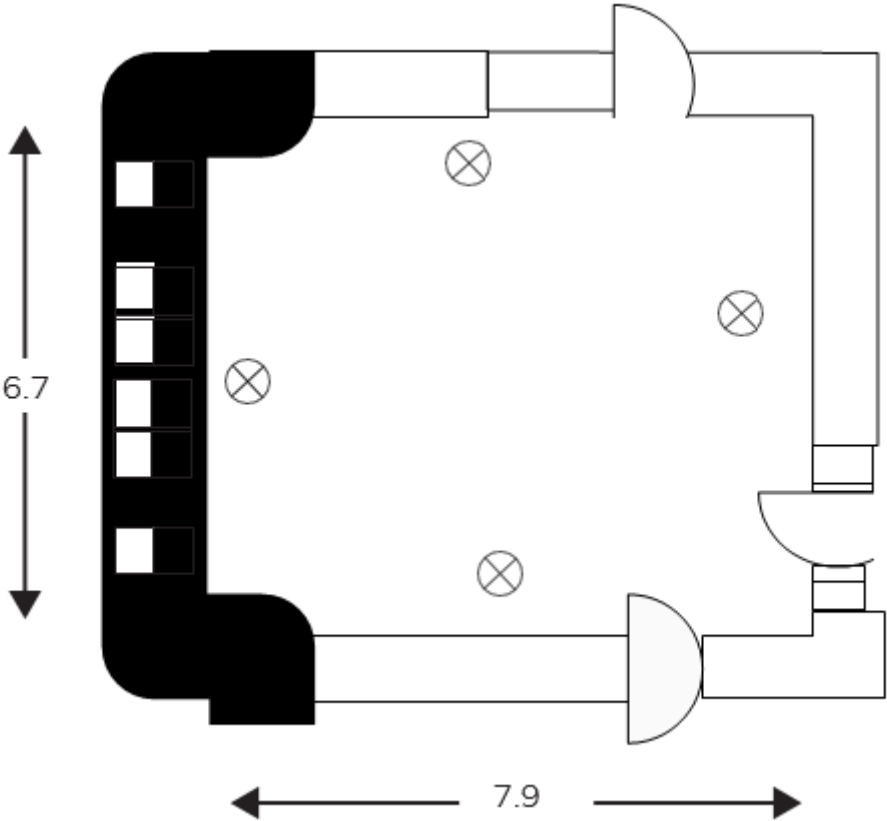

Examination Schools Floorplans
Room 9

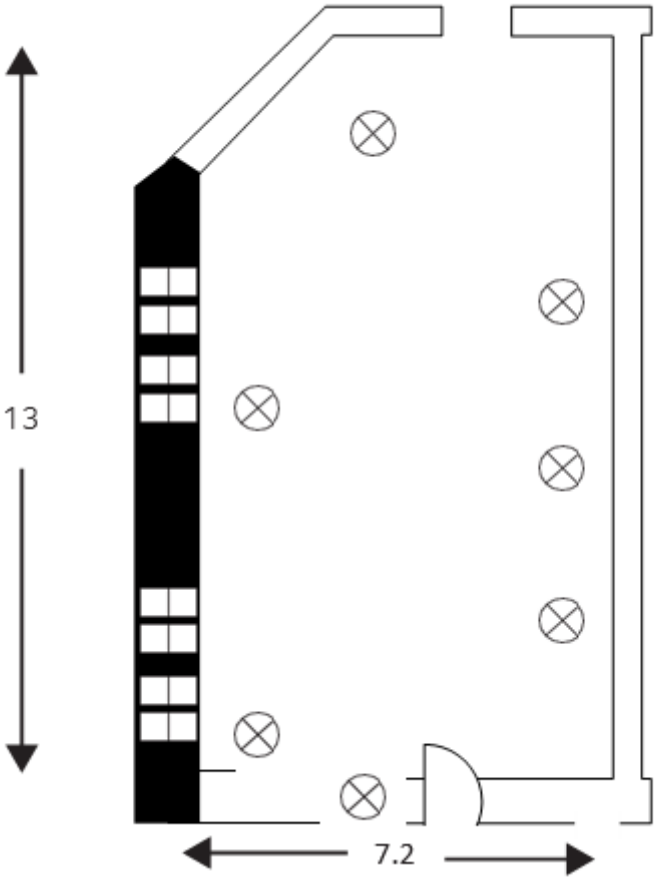

Examination Schools Floorplans
Room 10

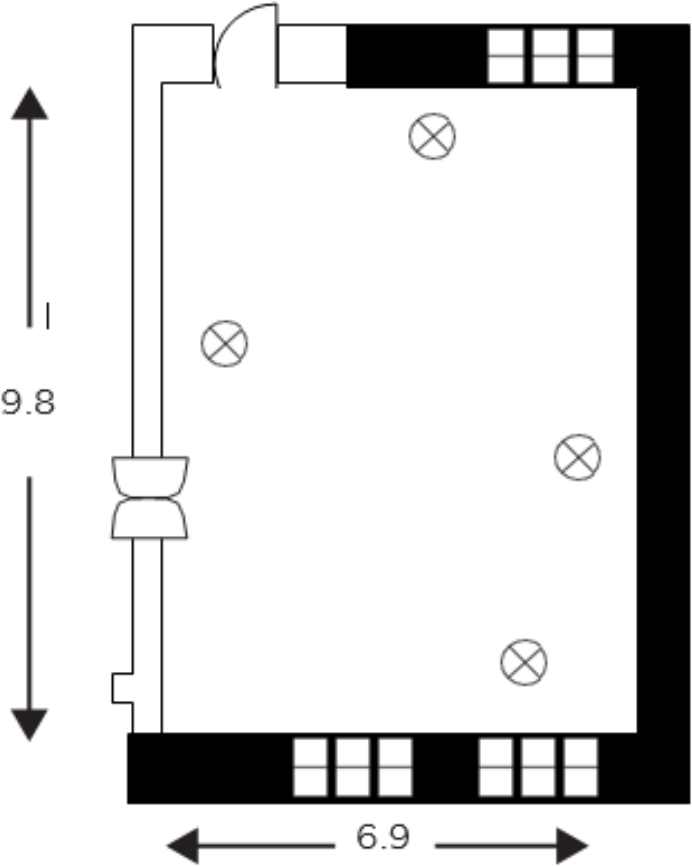

Examination Schools Floorplans
Room 11

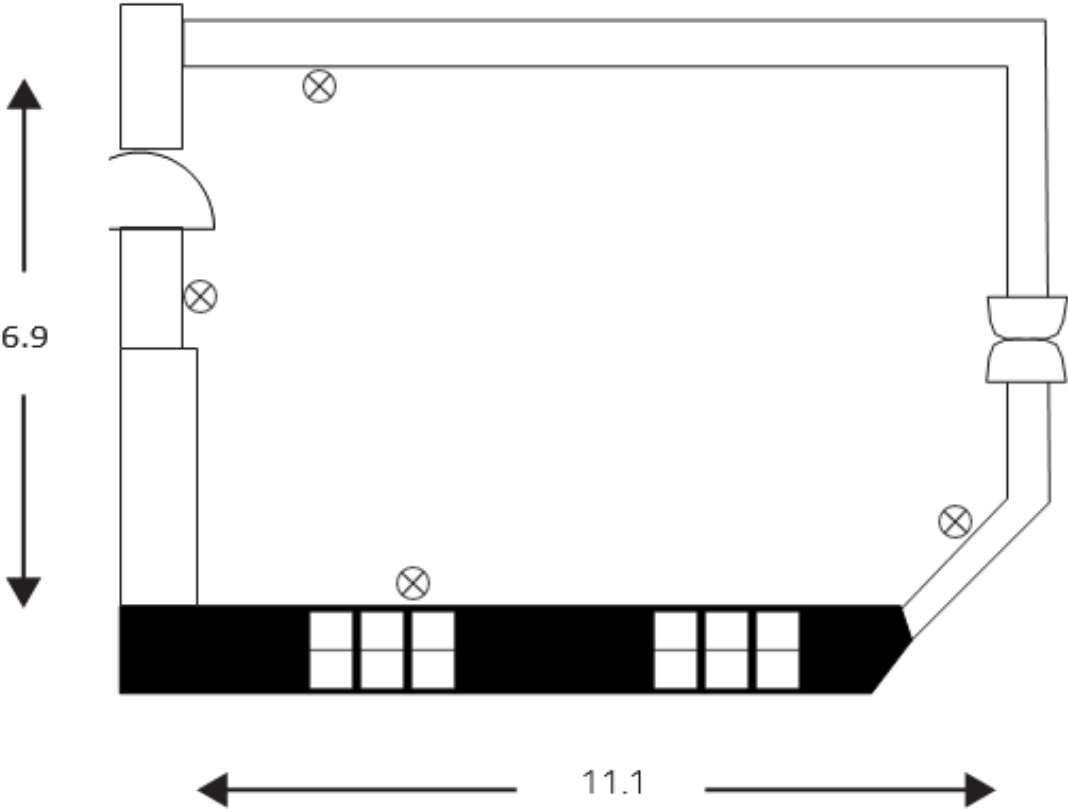

Examination Schools Floorplans
Room 12

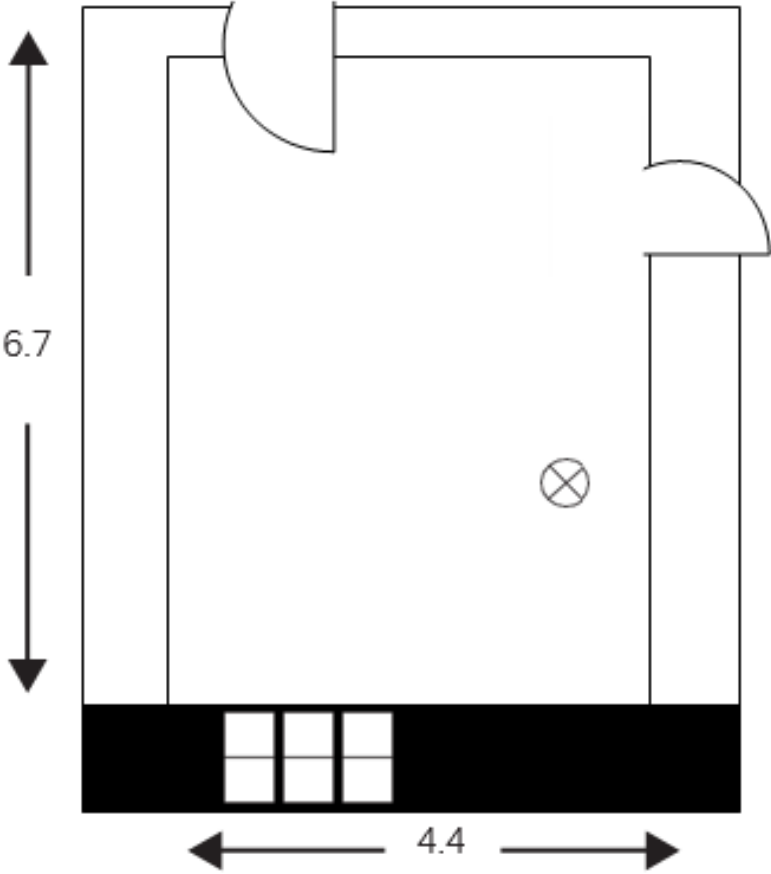

Examination Schools Floorplans

Room 14

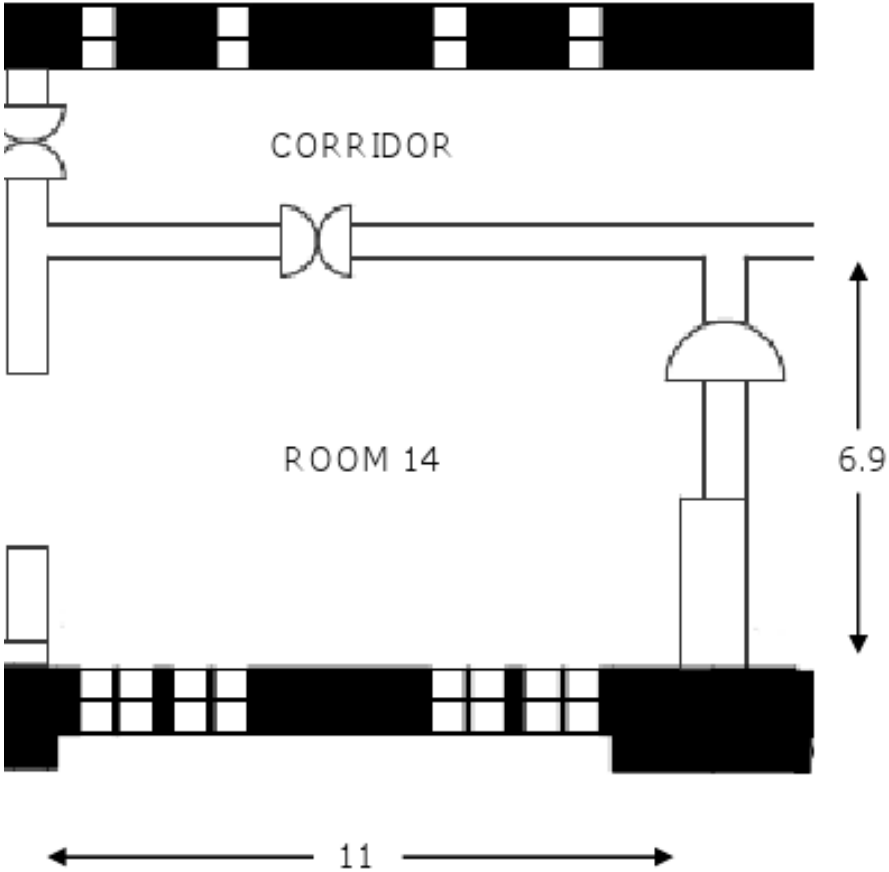

Examination Schools Floorplans
Room 15

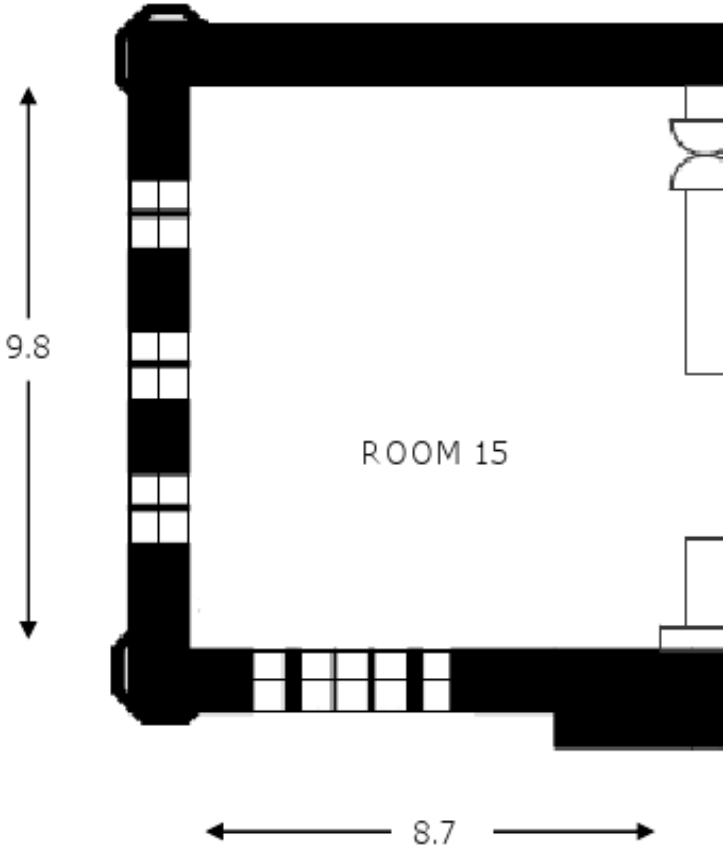

South Writing School

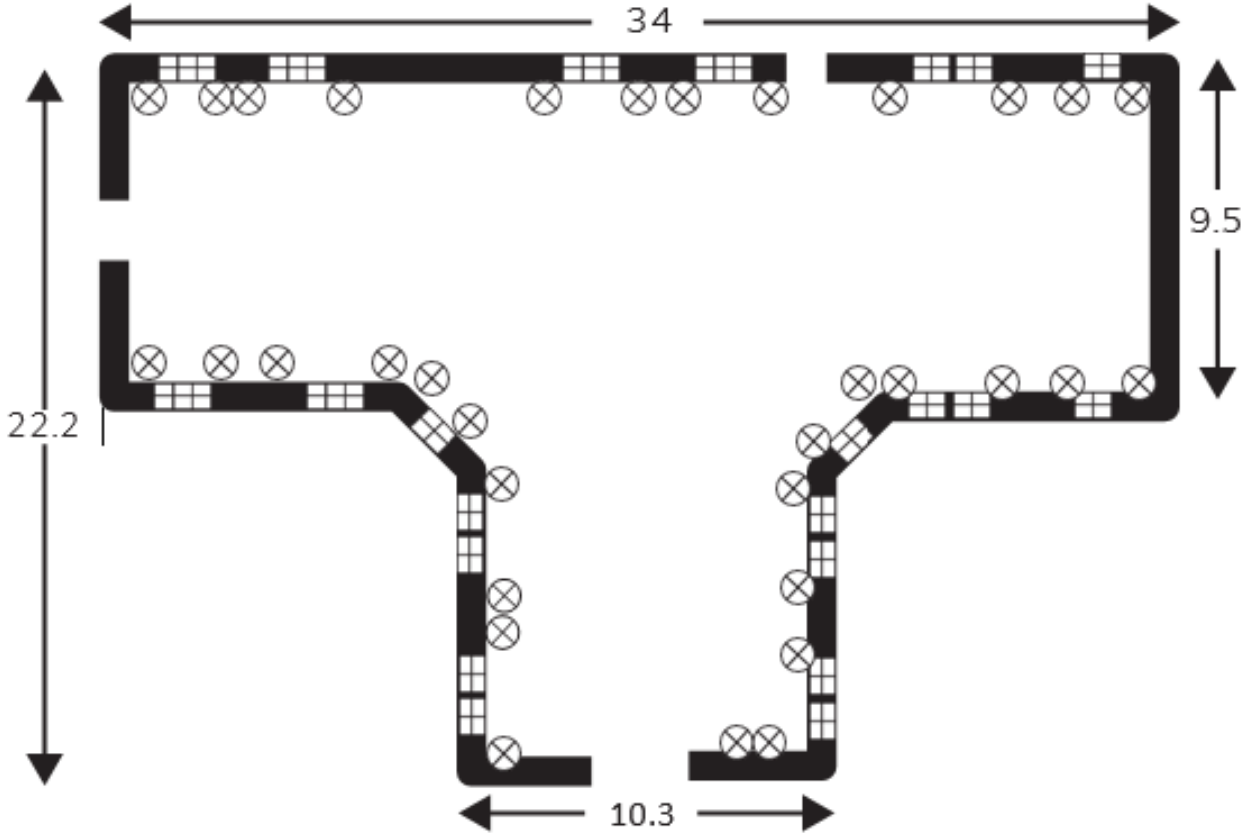

Examination Schools Floorplans
North Writing School

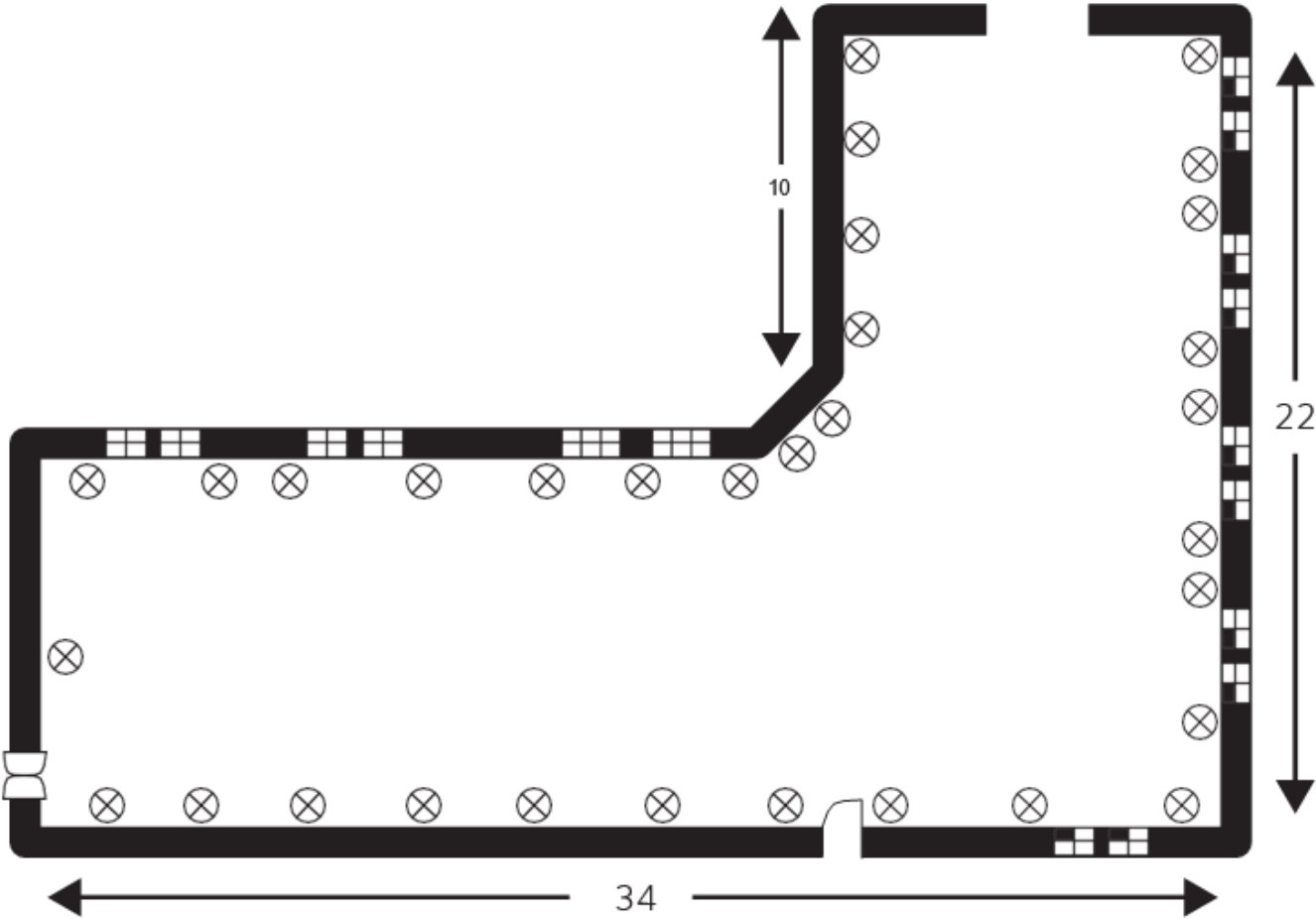

Examination Schools Floorplans
East Writing School

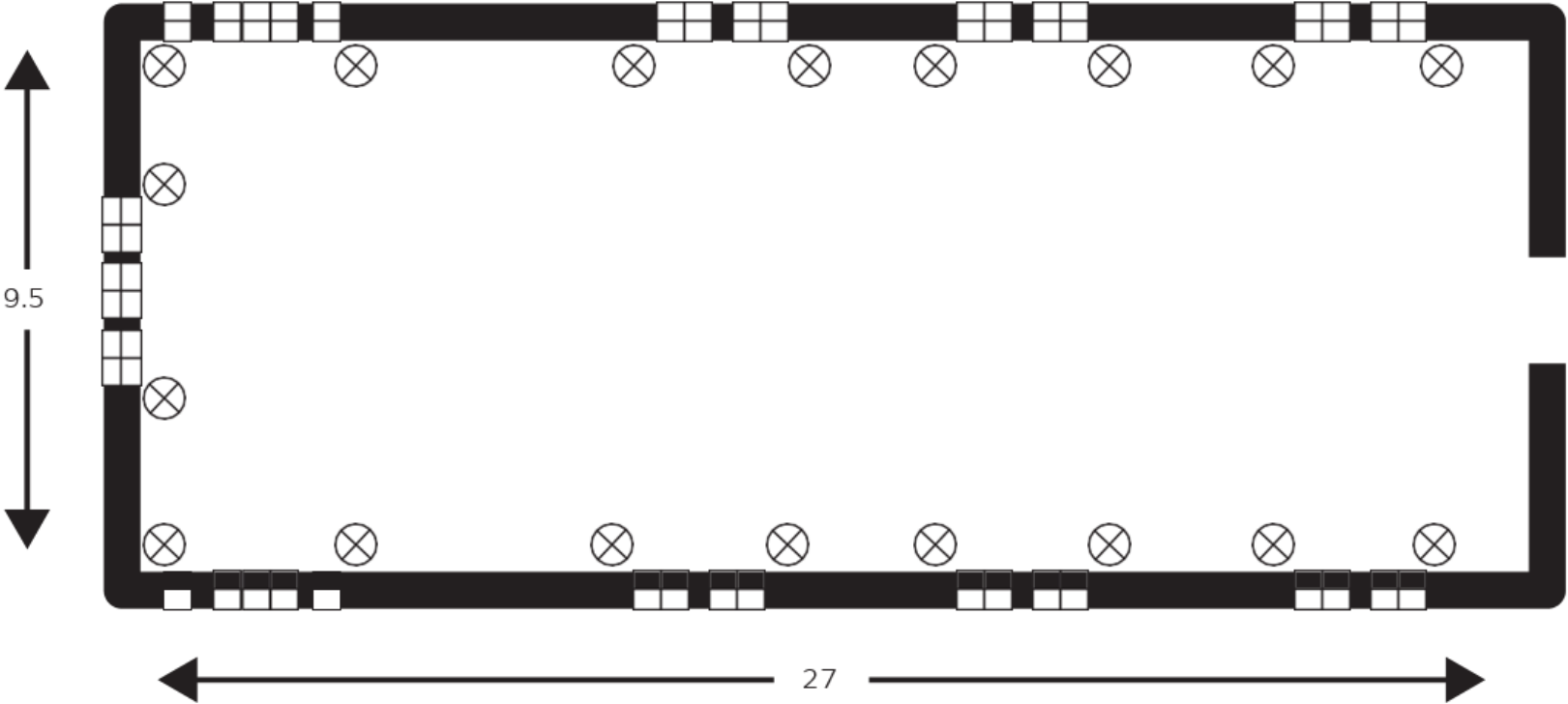

Examination Schools Floorplans
Great Hall

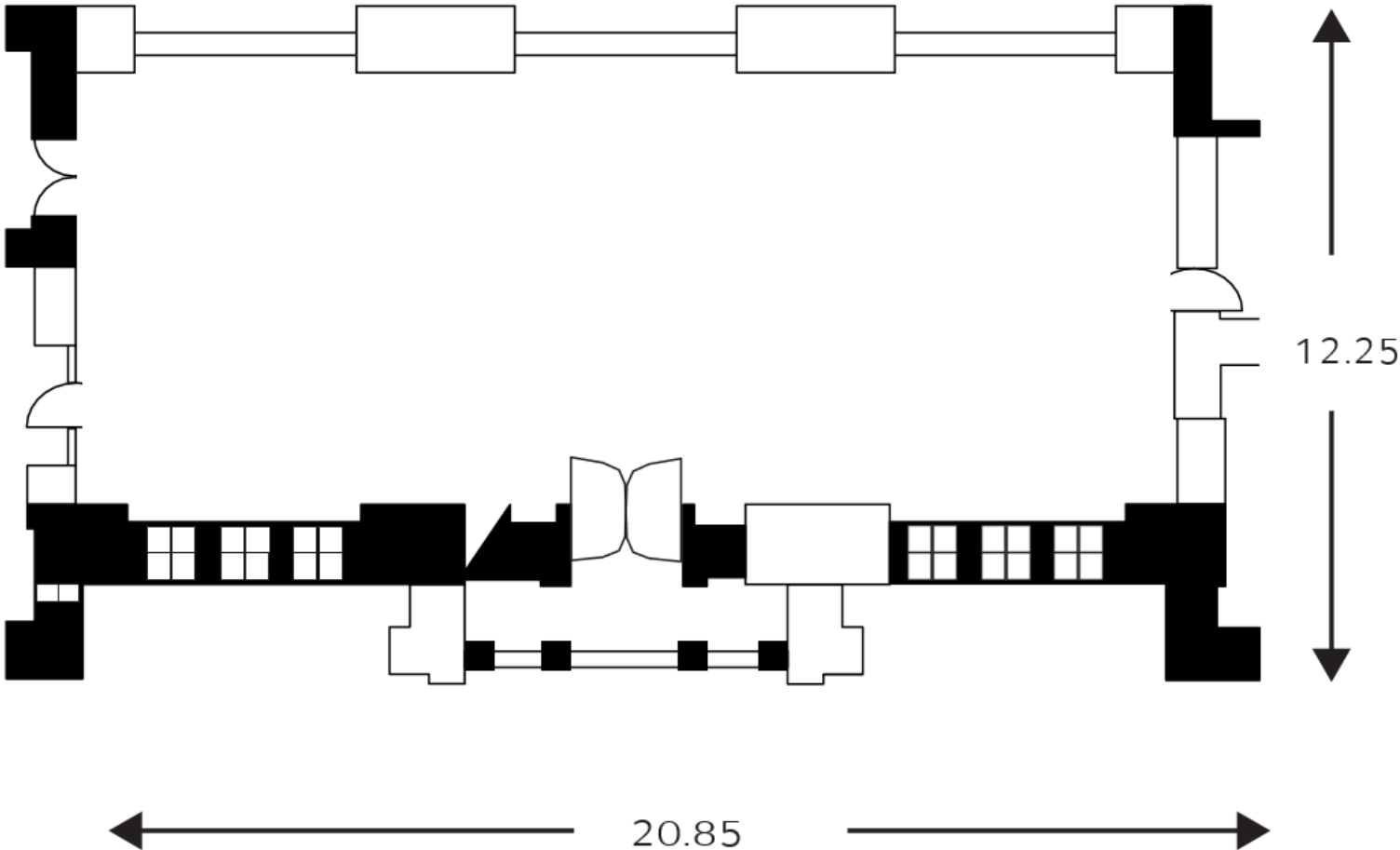

Examination Schools Floorplans
First Square

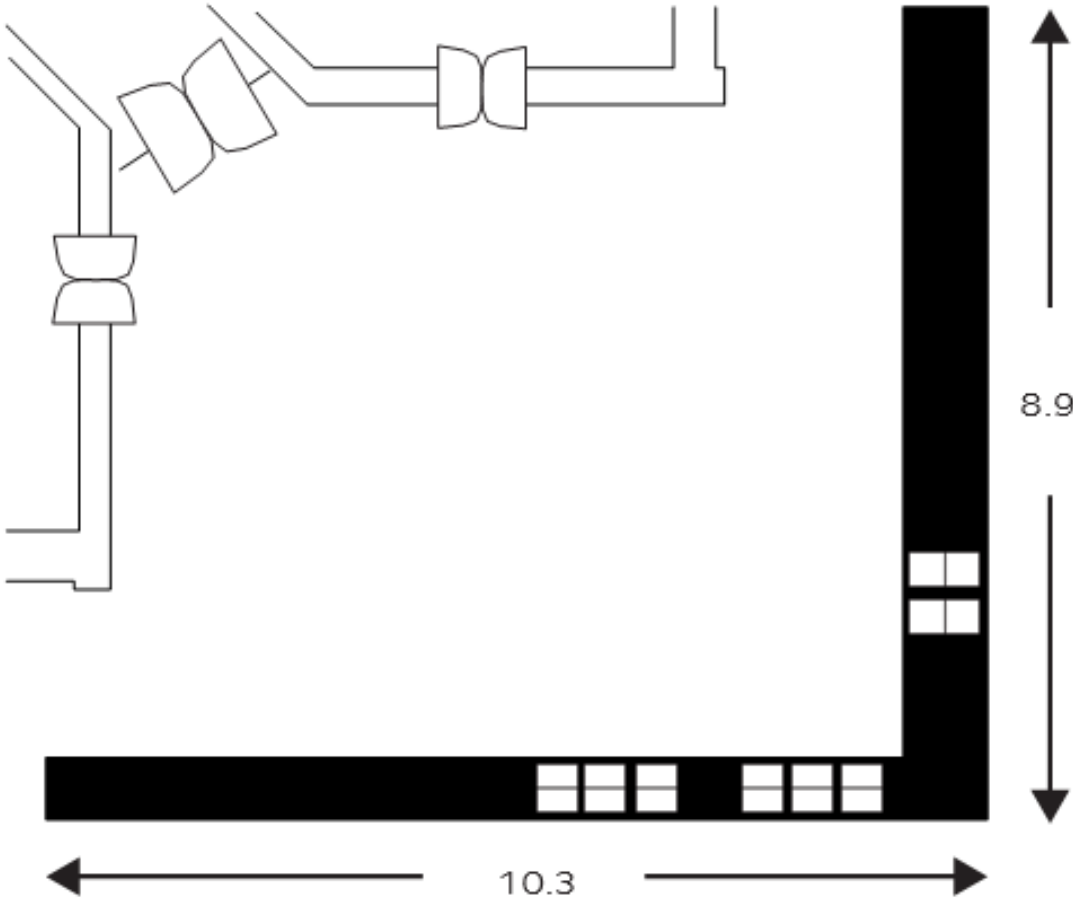

Examination Schools Floorplans
Second Square

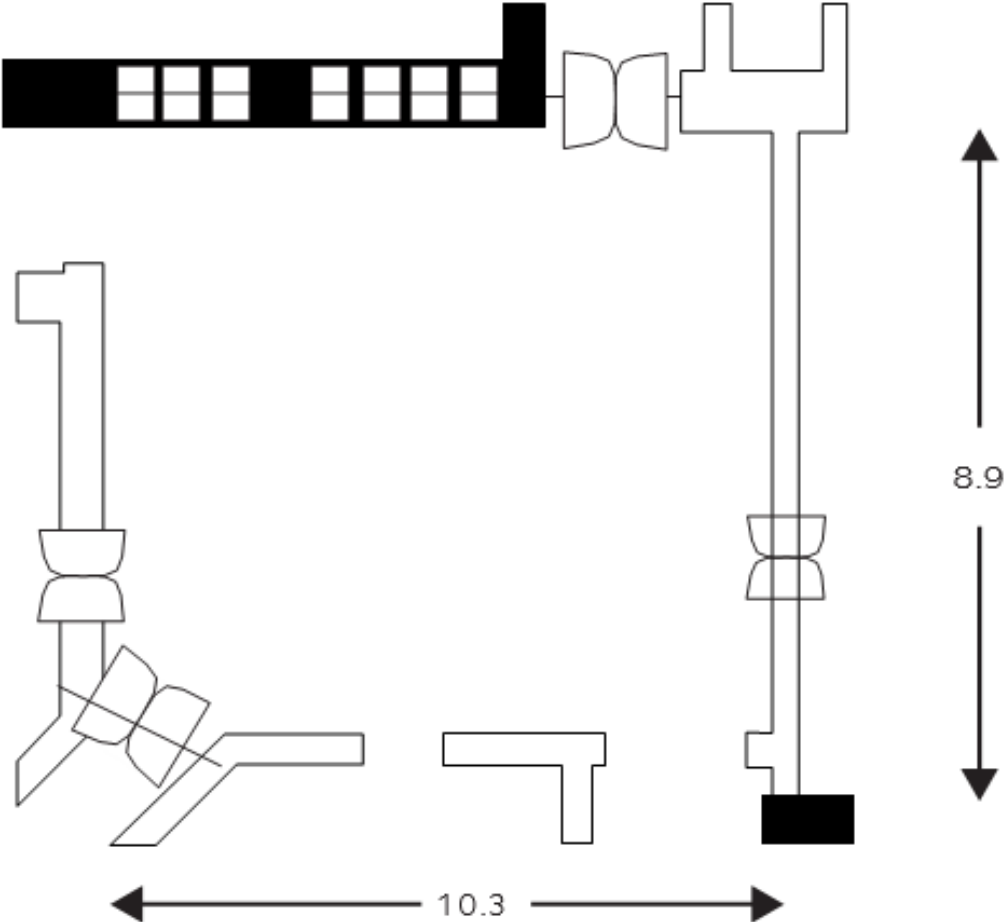

Examination Schools Floorplans
Quad

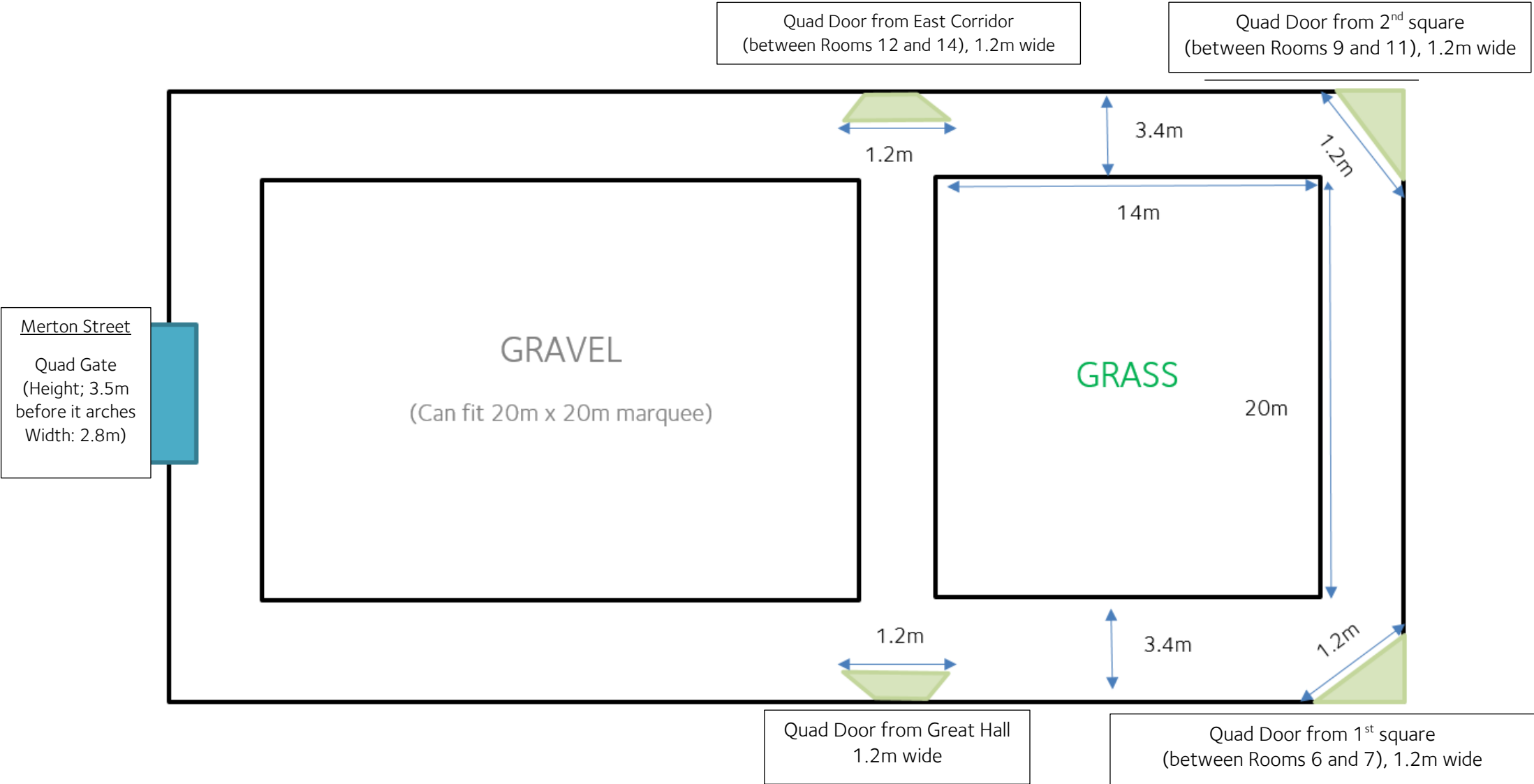

Sheldonian Theatre
Main Theatre

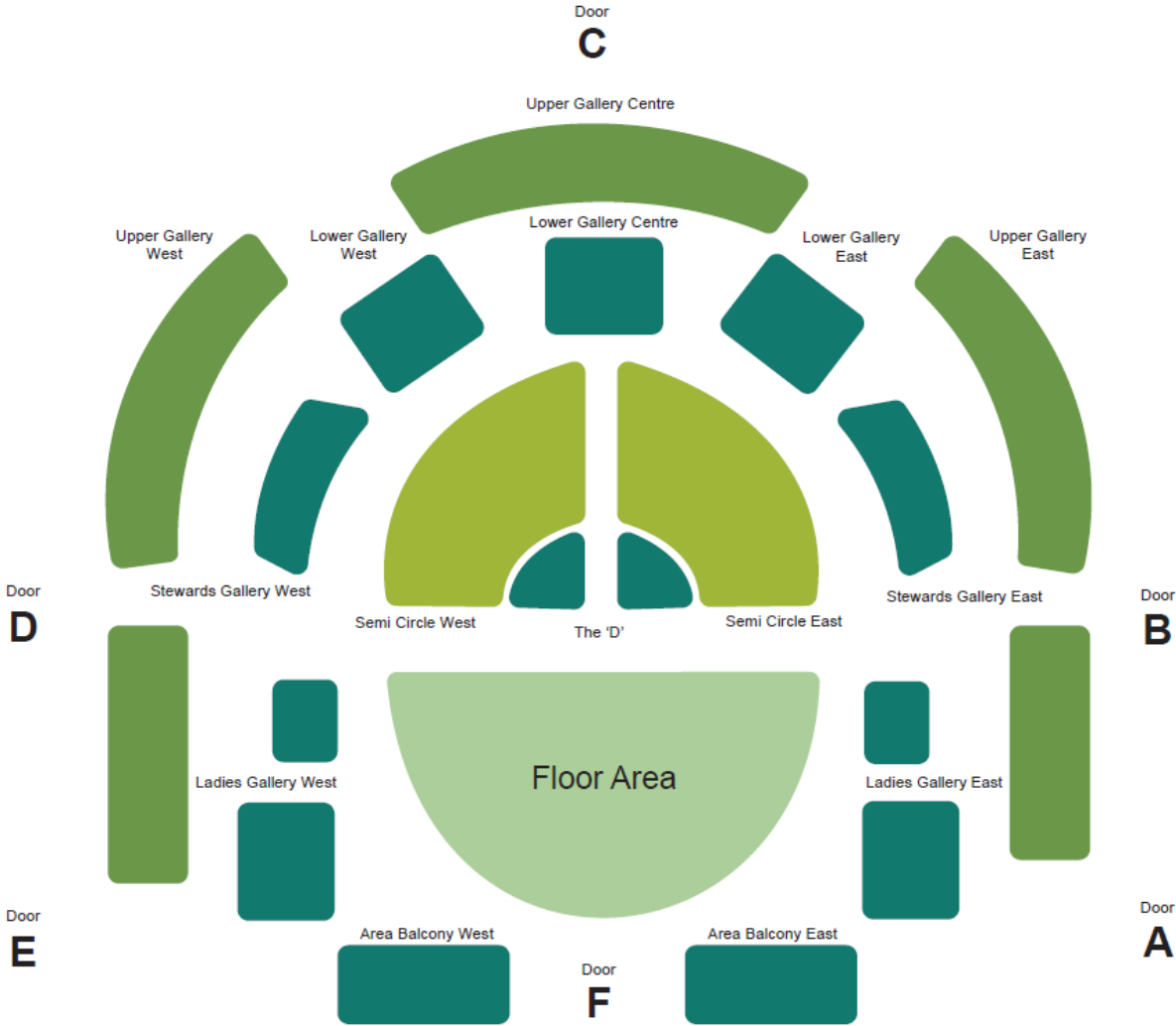

St Luke's Chapel
Main Room

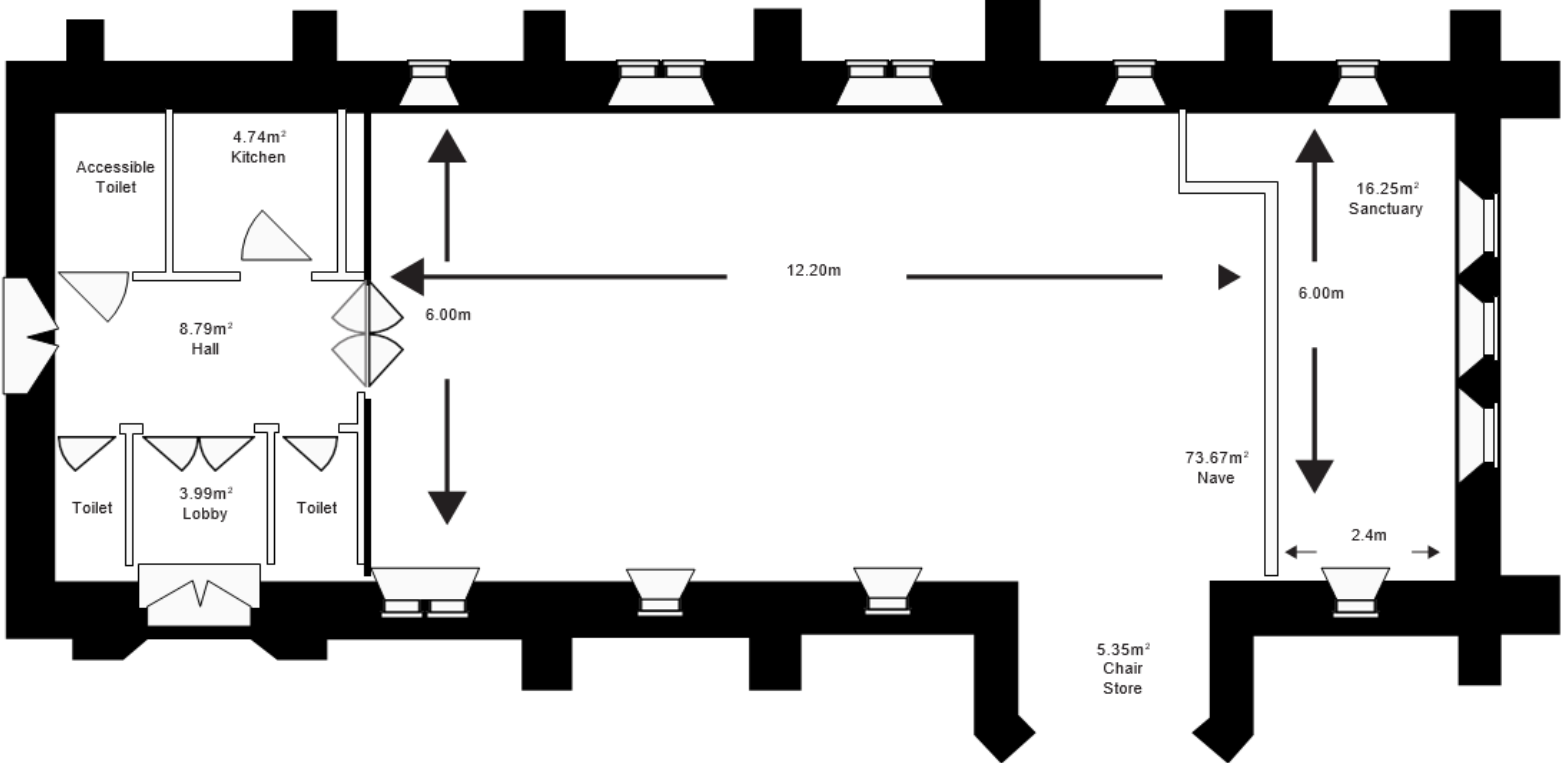

Osler House
Function Room

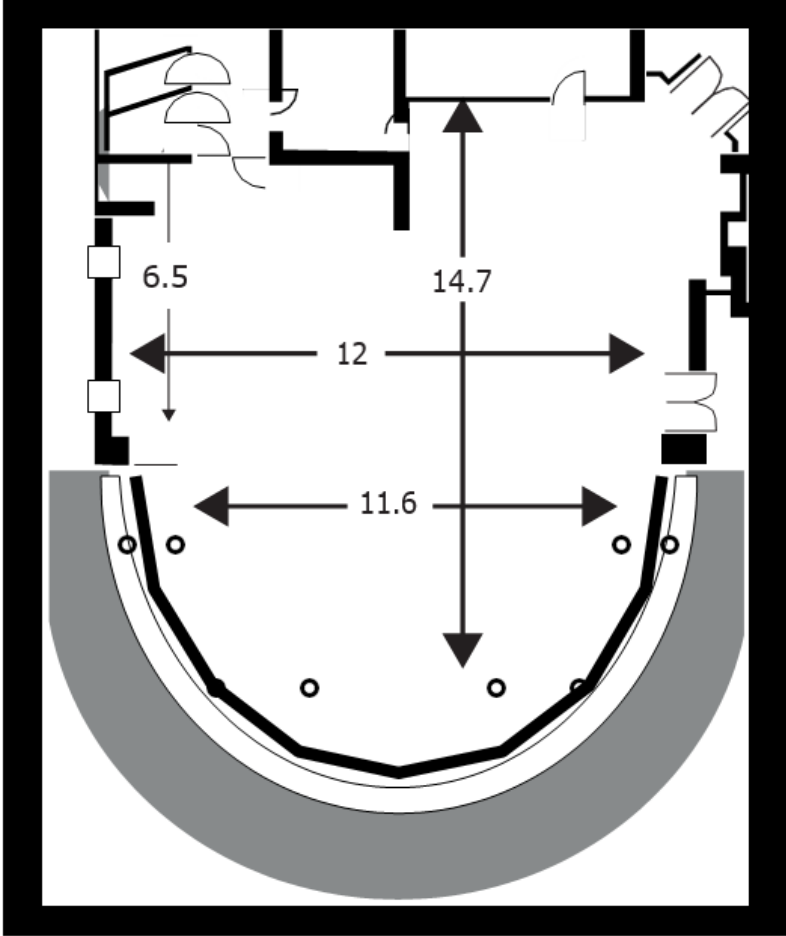

Osler House
Meeting Room 1

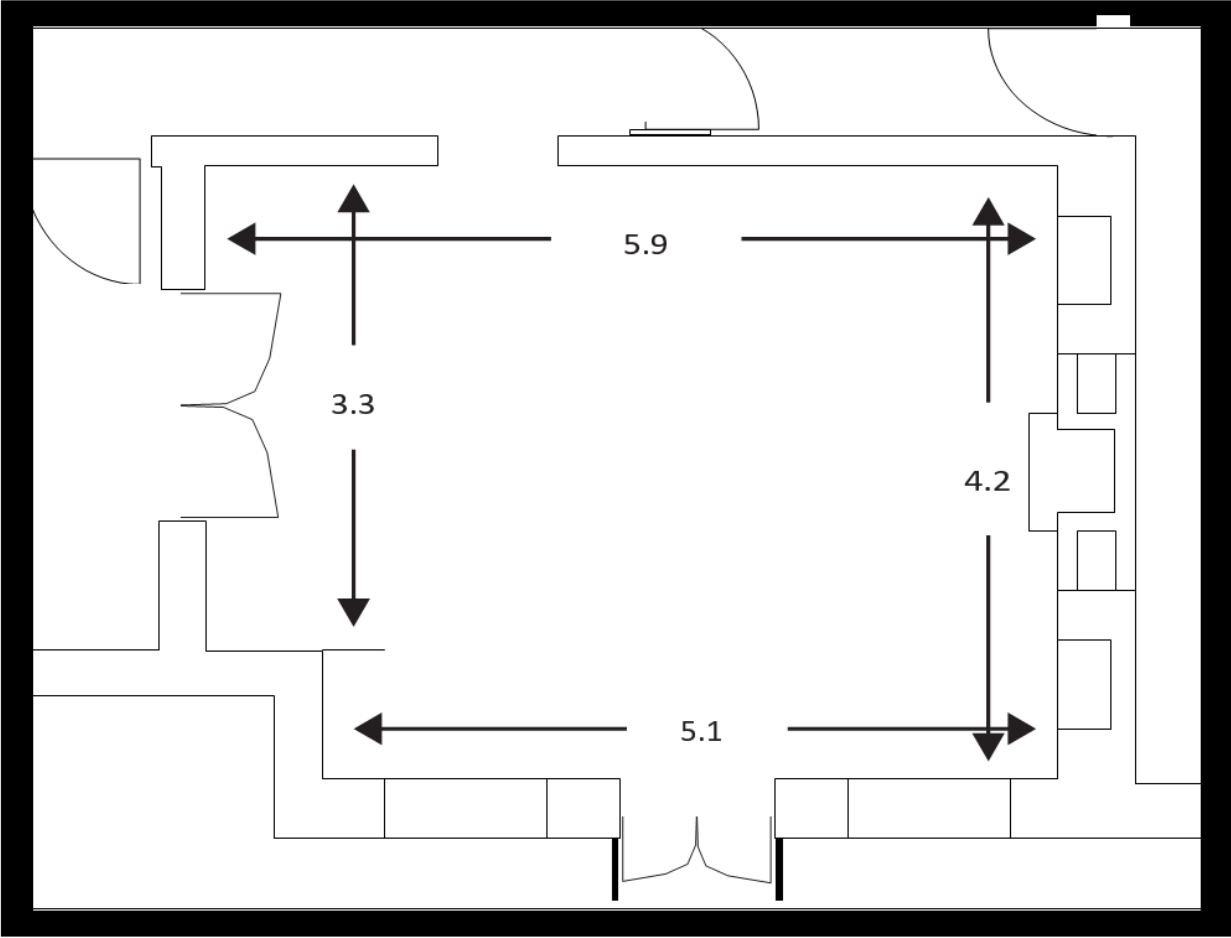

Osler House
Meeting Room 2

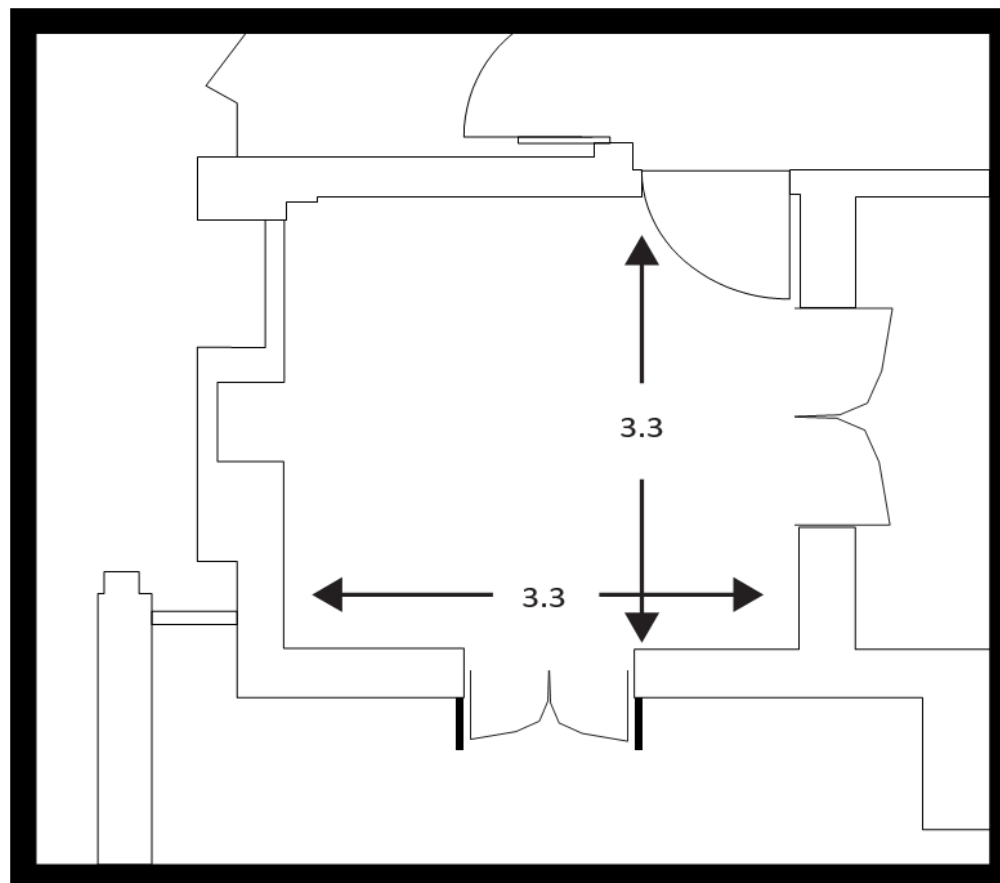

Osler House

Wing Tat Lee Room

